

DO NOT SCALE

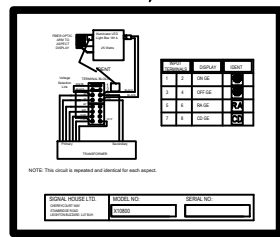

Scale 2:1

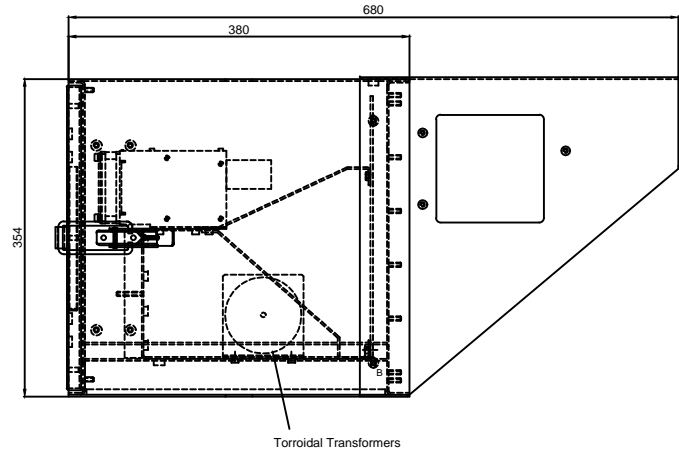
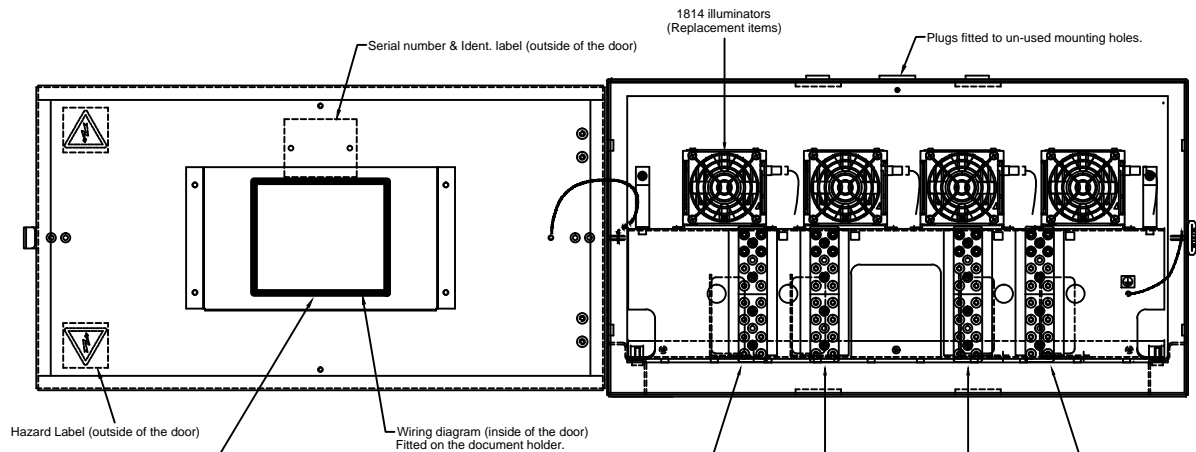
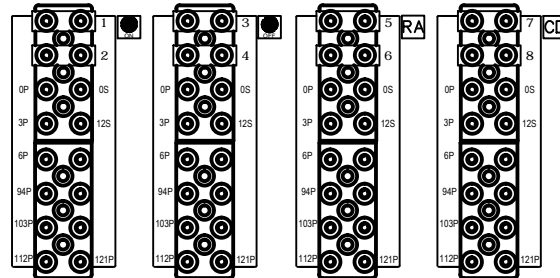

X10800 Display Scale 1:2

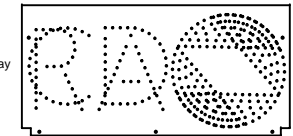

Supplied with Top Mounting kit: 130-43
 Weight: less than 30kg

Mounting holes punched in top and bottom of the case. Scale 1:2

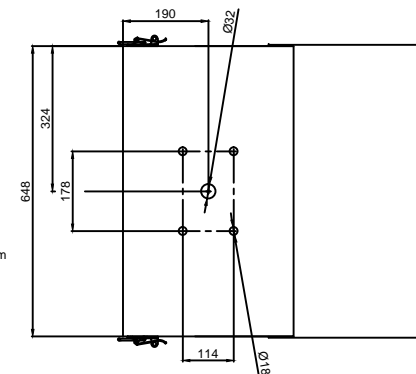

PADS: 086/001410

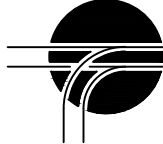
B	ECN350, PADS No: was 086/00/410 in error	PB	7/7/14	 <p>Tel : (01525) 377477 Fax : (01525) 850999 Email: sales@signalhouse.co.uk</p> <p>Signal House Ltd Signal House Chertycourt Way Stanbridge Road Leighton Buzzard Bedfordshire LU7 4UH</p>	SALES DATA	Drawn PB	Date 7/7/14	Title MARI RA/CD Mini Banner	
	Checked WAG					Date 7/7/14	Dimensions are in mm, unless specified otherwise.		
Issue	Drawing Revision Form no.	Name	Date			3rd Angle Projection		Drwg no. SD X10800 Data	Issue B

CONFIDENTIAL -
 THIS PRINT IS RELEASED TO YOU ON THE STRICT
 CONDITION THAT NONE OF THE DATA HEREON SHALL
 BE DIVULGED, REPRODUCED OR MADE AVAILABLE TO
 ANY THIRD PARTY, UNLESS WITH OUR WRITTEN
 CONSENT.