

DO NOT SCALE

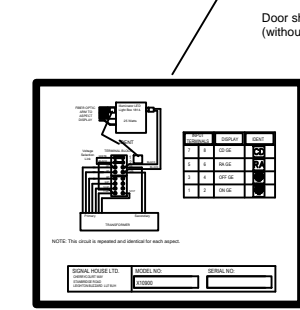

Scale 2:1

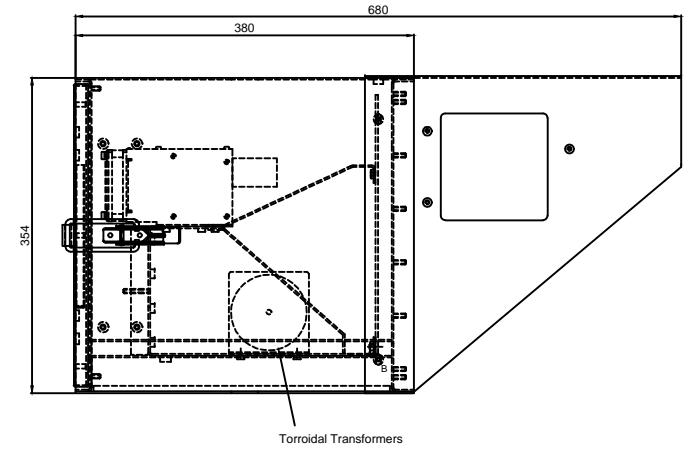
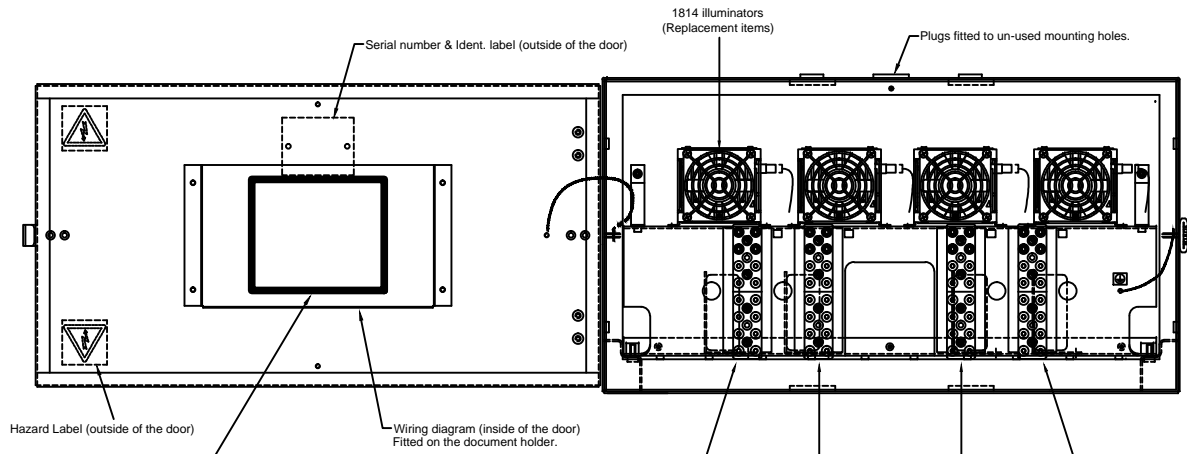
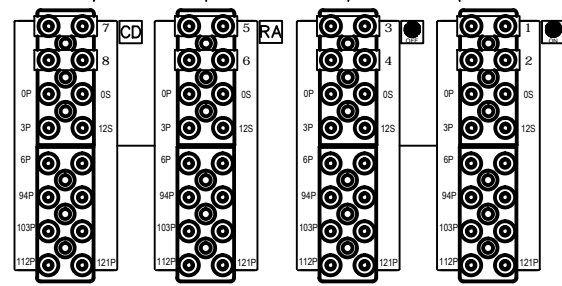

Scale 2:1

X10900 Display Scale 1:2

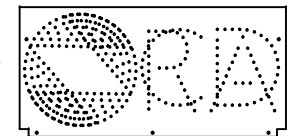

Supplied with Top Mounting kit: 130-43
Weight: less than 30kg

Mounting holes punched in top and bottom of the case. Scale 1:2

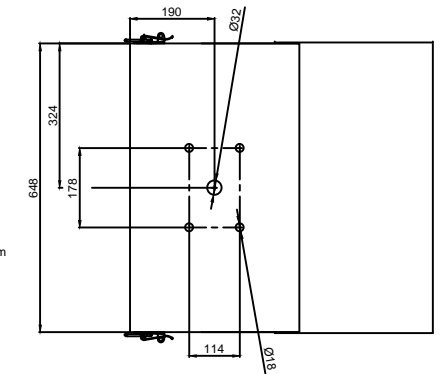

PADS: 086/001411

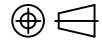
B	ECN350, PADS No: was 086/00/410 in error	PB	7/7/14	 <p>Tel : (01525) 377477 Fax : (01525) 850999 Email: sales@signalhouse.co.uk</p> <p>Signal House Ltd Signal House Cherrycourt Way Stanbridge Road Leighton Buzzard Bedfordshire LU7 4UH</p>	SALES DATA	Drawn PB	Date 7/7/14	Title MARI Mini Banner RA/CD
	Issue		Drawing Revision Form no.			Name	Date	
				<p>CONFIDENTIAL</p> <p>THIS PRINT IS RELEASED TO YOU ON THE STRICT CONDITION THAT NONE OF THE DATA HEREON SHALL BE DIVULGED, REPRODUCED OR MADE AVAILABLE TO ANY THIRD PARTY, UNLESS WITH OUR WRITTEN CONSENT.</p>		3rd Angle Projection		Drwg no. SD X10900 Data
								Issue B